

Features

- Bask® heated surface creates spa-like relaxation with soothing warmth on your back, shoulders, and neck.
- Three heat settings allow you to customize the surface temperature.
- Comfort Depth® design offers a convenient 19" step-over height while retaining the same depth as a standard 21" bath.
- Integral lumbar support.
- Slotted overflow allows for deep soaking.
- Integral apron.
- Integral flange helps prevent water from seeping behind wall and simplifies alcove installation.
- Textured bottom surface.
- Coordinates with other products in the Archer collection.

Material

- Acrylic.

Installation

- Left drain.
- Requires K-7271 or K-7272 Clearflo slotted overflow bath drain (sold separately).
- Alcove.

Required Products/Accessories

K-7271 Brass Slotted Overflow Bath Drain

or

K-7272 PVC Slotted Overflow Bath Drain

Recommended Products/Accessories

K-1491 Bath/Whirlpool Pillow

K-1601 Bath/whirlpool footstop, removable

K-24916 Wireless Music Kit

K-23726 Drain treatment

K-23732 Tub & shower cleaner



ADA

Codes/Standards

CSA B45.5/IAPMO Z124

ASTM E162

ASTM E662

UL 1795

ADA









ICC/ANSI A117.1

KOHLER® Plastic Baths and Receptors Lifetime Limited Warranty KOHLER® Hydrotherapy Components Five-Year Limited Warranty

See website for detailed warranty information.

Available Colors/Finishes

Color tiles intended for reference only.

Color	Code	Description
	0	White
	96	Biscuit
	NY	Dune
	95	Ice™ Grey
	G9	Sandbar
	K4	Cashmere
	58	Thunder™ Grey
	7	Black Black™

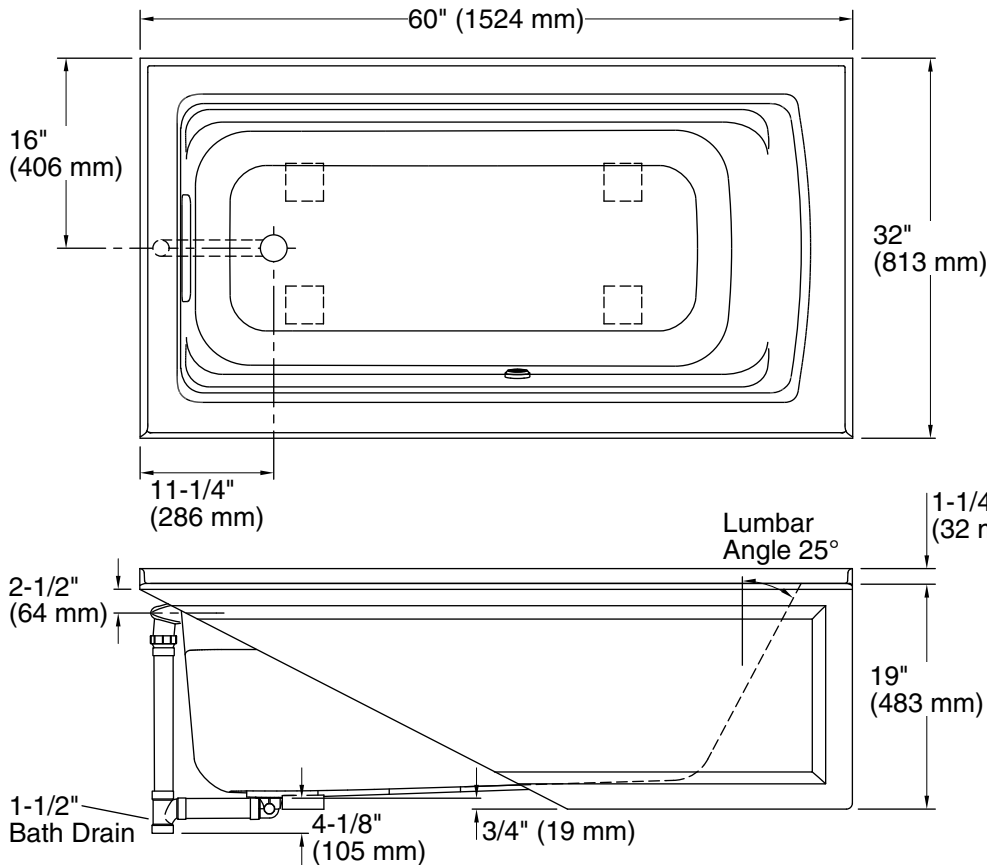

No change in measurements if connected with drain illustrated. (K-7272)

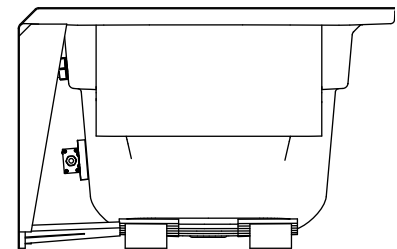
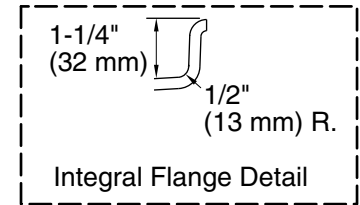

Required Electrical Service

One circuit required, protected with Class A Ground-Fault Circuit-Interrupter (GFCI). Outside North America, this device may be known as a Residual Current Device (RCD).

Heated Surface: 120 V, 15 A

Technical Information

All product dimensions are nominal.

Installation: Three-wall alcove

Drain location: Left

Basin area, bottom: 45-1/8" x 19-11/16" (1146 mm x 500 mm)

Basin area, top: 52-3/4" x 25-5/16" (1340 mm x 643 mm)

Weight: 80 lbs (36.3 kg)

Minimum floor load: 45 lbs/ft² (219.7 kg/m²)

Water depth: 15" (381 mm)

Water capacity: 58 gal (219.6 L)

Electrical component rating: Heated Surface: 120 V, 0.5 A, 60 Hz, 65 W

Minimum flat for door: 2-3/16" (56 mm)

Notes

Measure your actual product for rough-in details.

Install this product according to the installation instructions.

The hot water supply should be 70% of the capacity of the bath or greater. Installations will vary.

ADA compliant when installed to the specific requirements of these regulations.